

TRIL

MAIN FEATURES

- 16A switching capabilities.
- 1 & 2 pole configurations.
- 5KV/10mm dielectric coil to contacts.
- Low height of 15.7mm.
- Sealed & Unsealed types available.



APPLICATIONS

- Microwave Oven; Facsimile; Refrigerator, Air Conditioner, Stereo Equipment; Copiers, TV Set, Monitor, Vending Machine, Temperature Controller, etc.

ORDERING INFORMATION

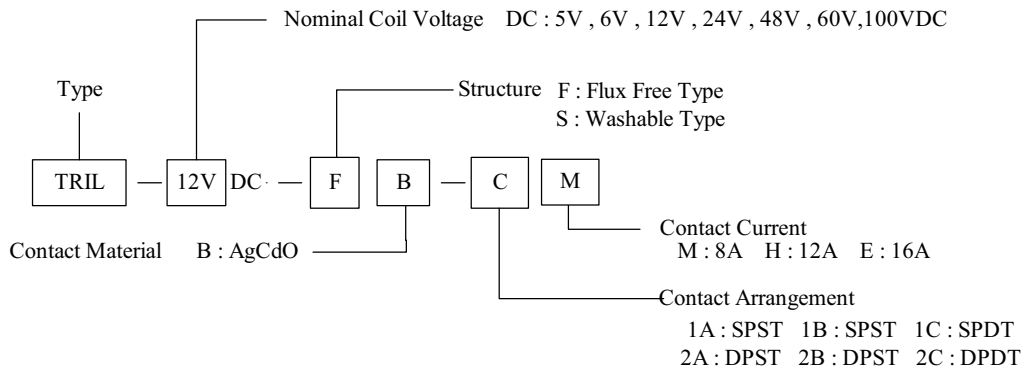

DIMENSION (unit:mm)

DRILLING (unit:mm)

WIRING DIAGRAM

• PC Board Layout (T=2.52± 0.05mm)

5mm 2 Pole 8A

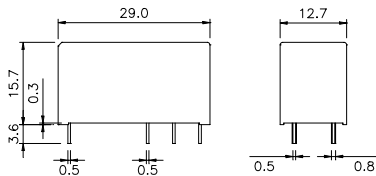

TRIL-CM

TRIL-AM

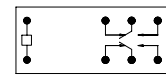
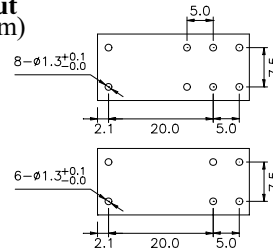

3.5mm 1 Pole 12A

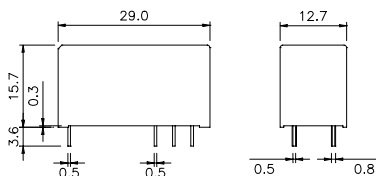

TRIL-CH

TRIL-AH

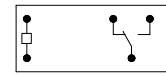
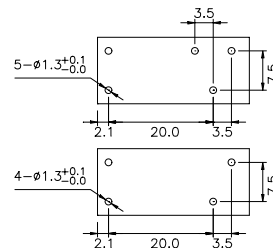

5mm 1 Pole 16A

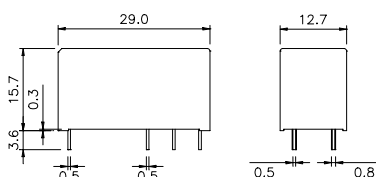

TRIL-CE

TRIL-AE

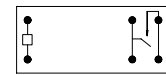
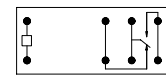
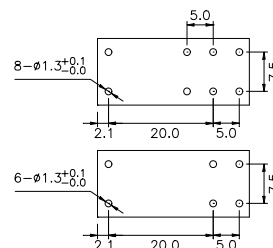

■ COIL DATA CHART (AT20°C)

Coil Sensitivity	Coil Voltage Code	Nominal Voltage (VDC)	Nominal Current (mA)	Coil Resistance (Ω) \pm 10%	Power Consumption (W)	Pull-In Voltage (VDC)	Drop-Out Voltage (VDC)	Max-Allowable Voltage (VDC)
TRIL	005	5	80.6	62	abt. 0.4W	70% Max.	10% Min.	110% Max.
	006	6	66.7	90				
	012	12	33.3	360				
	024	24	16.7	1440				
	048	48	8.3	5760 \pm 15%				
	060	60	8.0	7500 \pm 15%				
	110	110	4.3	25200 \pm 15%				

■ CONTACT RATING

Item	Type	SPST (1A/1B) , SPDT (1C)		DPST (2A/2B) , DPDT (2C)
		TRIL-E	TRIL-H	TRIL-M
Contact Capacity		16A 250VAC	12A 250VAC	8A 250VAC
Resistive Load ($\cos\Phi=1$)		16A 30VDC	12A 30VDC	8A 30VDC
Inductive Load ($\cos\Phi=0.4$ L/R=7msec)		4A 250VAC 4A 30VDC	5A 250VAC 5A 30VDC	2A 250VAC 3A 30VDC
Rated Carrying Current		16A	12A	8A
Max. Allowable Voltage		380VAC/125VDC		
Max. Allowable Current		16A	12A	8A
Max. Allowable Power Force		4000VA/480W	3000VA/360W	2000VA/240W
Contact Material		Ag Alloy		

■ REFERENCE DATA

1 Pole 12/16A

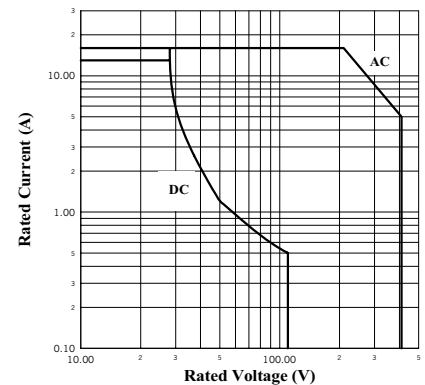

2 Pole 8A

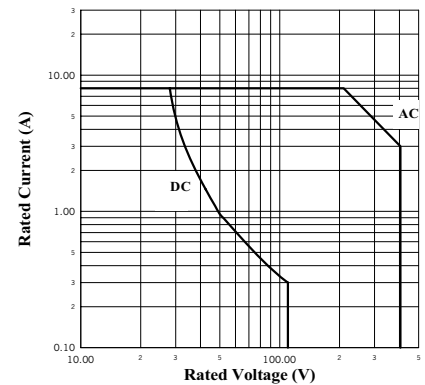

■ PERFORMANCE (at initial value)

Item	Type	TRIL
Contact Resistance		50m Ω Max (measured at 1A 6VDC).
Operation Time		7msec Max.
Release Time		3msec Max.
Dielectric Strength		
Between coil & contacts		5000VAC, 1min
Between open contacts		1000VAC, 1min
Between Contact sets		2500VAC, 1min
Insulation Resistance		1000 M Ω Min. (500VDC)
Operating Ambient Temperature		-40° C to +70° C
Operating Humidity		35% to 85% RH
Vibration Resistance		30 to 150HZ Double Amplitude 1.5mm
Shock Resistance		100 m/s ²
Life Expectancy		
Mechanically		1 \times 10 ⁷ ops. Min. (7200 OPS/Hour)
Electrically		1 \times 10 ⁵ ops. Min. (360 OPS/Hour)
Weight		abt. 13.5grs.